

**Classification:**  
 EL08-022b

**Reference:**  
 ITB08-037b

**Date:**  
 January 12, 2009

## EX35, G35, G37, M, QX56; RADIO WILL NOT SCROLL THROUGH ALL PRESETS (NAVI-EQUIPPED ONLY)

This bulletin has been amended. Action and Service Procedure have changed.  
 Please discard all previous versions of this bulletin.

**APPLIED VEHICLES:** 2008 EX35 (J50) with NAVI  
 2008 G37 (CV36) with NAVI  
 2007 – 2008 G35 (V36) with NAVI  
 2007 – 2008 M (Y50) with NAVI  
 2008 – 2009 QX56 (JA60) with NAVI

**APPLIED VIN / DATE:** EX35 2WD vehicles built before: JNKAJ09E(\*)8M306060 / 3-18-08  
 EX35 AWD vehicles built before: JNKAJ09F(\*)8M360417 / 3-18-08  
 G35 2WD vehicles built before: JNKBV61E(\*)8M220079 / 3-21-08  
 G35 AWD vehicles built before: JNKBV61F(\*)8M269306 / 3-21-08  
 G37 vehicles built before: JNKCV64E(\*)8M125026 / 3-21-08  
 M35 2WD vehicles built before: JNKBY01E(\*)8M500896 / 3-25-08  
 M35 AWD vehicles built before: JNKBY01F(\*)8M551256 / 3-25-08  
 M45 2WD vehicles built before: JNKAY01E(\*)8M606732 / 3-24-08  
 M45 AWD vehicles built before: JNKAY01F(\*)8M655078 / 3-24-08  
 QX56 vehicles built before: 5N3AA08(\*\*)9N900007 / 4-9-08

**IF YOU CONFIRM:**

Radio presets in A, B, or C will not scroll through all 6 preset stations.

**ACTION:**

Update the audio system software using the procedure in this bulletin.

**NOTE:** Make sure to use 08-09 or later Map Data Master Discs.

**CLAIMS INFORMATION**

Submit a Primary Operation (PO) line claim using the following claims coding:

DESCRIPTION	OP CODE	SYM	DIA	FRT
Audio System Software Update	RX84AA	HB	32	0.6

**IMPORTANT:** The purpose of "ACTIONS" (above) is to give you a quick idea of the work you will be performing. You **MUST** closely follow the entire Service Procedure as it contains information that is essential to successfully completing this repair.

 Infiniti Bulletins are intended for use by qualified technicians, not 'do-it-yourselfers'. Qualified technicians are properly trained individuals who have the equipment, tools, safety instruction, and know-how to do a job properly and safely. **NOTE:** If you believe that a described condition may apply to a particular vehicle, **DO NOT** assume that it does. See your Infiniti dealer to determine if this applies to your vehicle.

## SERVICE PROCEDURE

The HDD update kit (P/N: J-48850) and 08–09 Map Data Master Discs (2 disc set – J-48850-MY09) are required to update the audio system software. These items were previously shipped to each dealer as part of the essential tool program.

- 08–09 Map Data Master Discs (2 disc set).



Figure A

### HDD update kit contents

- A. HDD Rewrite software (obsolete; now available via ASIST synchronization)
  - B. 07-08 HDD Data Upgrade Master Disc 1 & 2 (superseded by 08-09 discs)
  - C. CF (Compact Flash) Adapter
  - D. USB cable
- These items can be purchased from TECH-MATE at 1-800-662-2001

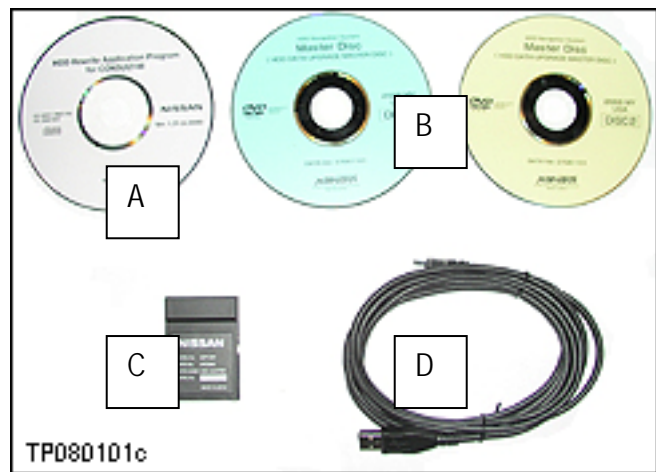

Figure B

**NOTE:** The HDD update kit was assembled prior to the availability of ASIST download for the HDD rewrite software. The kit also includes the 07-08 Upgrade Master Discs which have been superseded by the 08-09 Map Data Master Discs. Discs "A" and "B" above are no longer needed.

### **IMPORTANT:**

- Make sure your ASIST has been freshly synchronized and all C-III upgrades have been installed. The HDD (Hard Disc Drive) rewrite software is delivered to your C-III via ASIST synchronization.
- If the ASIST has been freshly synchronized then HDD rewrite software is on your C-III.

## Overview of the Audio System Software Update

This procedure is divided into 5 sections. Complete each section in the following order:

SECTION 1: Installing the Map Data Master Discs into the CONSULT-III (C-III).....	Page 3
(This is required only once)	
SECTION 2: Connecting C-III to the Audio System.....	Page 9
SECTION 3: Updating the Audio System.....	Page 10
SECTION 4: Disconnecting the C-III and CF (Compact Flash) Adapter.....	Page 14
SECTION 5: Verifying the Update Result.....	Page 16

### SECTION 1: INSTALLING THE MAP DATA MASTER DISCS INTO THE C-III

- The audio system update software is contained on the 08–09 Map Data Master Discs (2-disc set – J-48850-MY09). See page 2.
- The 08–09 Map Data Master Discs need to be installed on your C-III only once. It is not necessary to install the Data Master Discs each time you perform an audio system update.
- If 08–09 Map Data Master Discs are already installed in your C-III computer, you can skip to Section 2 on page 9.

1. Connect the C-III DVD drive to the C-III computer with the USB cable.
2. Turn ON the C-III computer.
3. Open / start ASIST.



Figure 1-1

- 4. Select Information Tool Box and HD Navi. Tools.



Figure 1-2

- 5. Select Install Map Update



Figure 1-3

6. Select **Installing updated map**

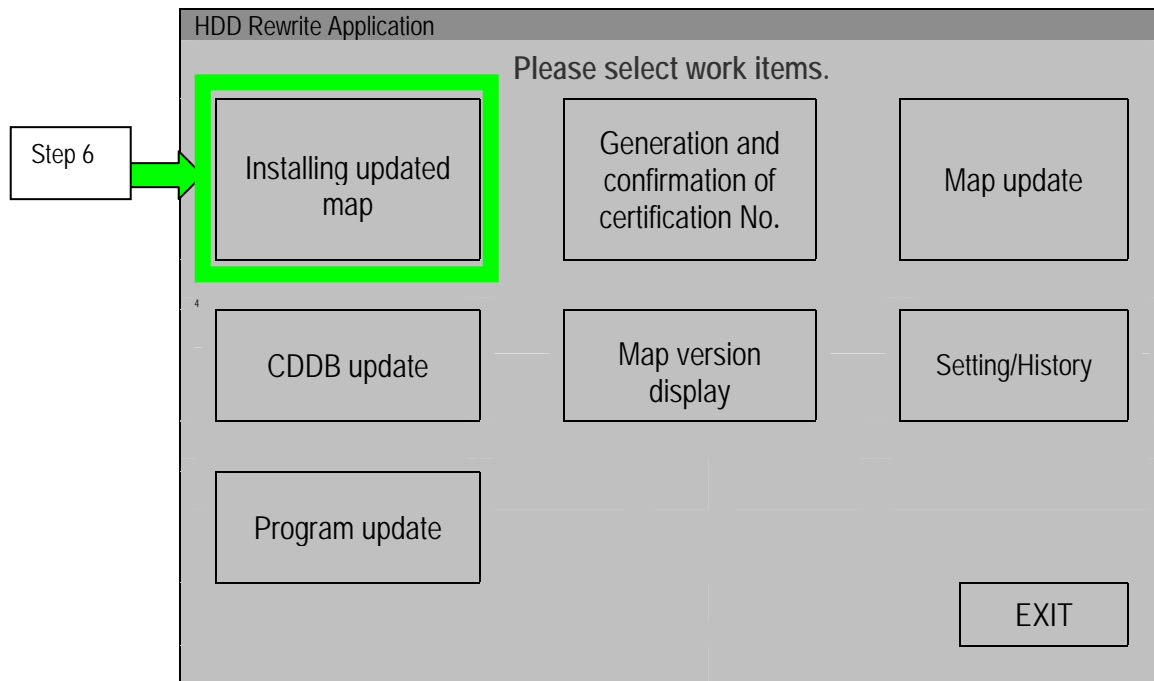

Figure 1-4

7. Insert the Map Data Master Disc 1 into the C-III DVD drive.

8. Confirm the correct name of the DVD drive is displayed (see Figure 1-5).

- "E" is likely the correct name for the DVD drive.
- The DVD drive name may be different depending on the drive configuration of your C-III computer.

9. Select **START**

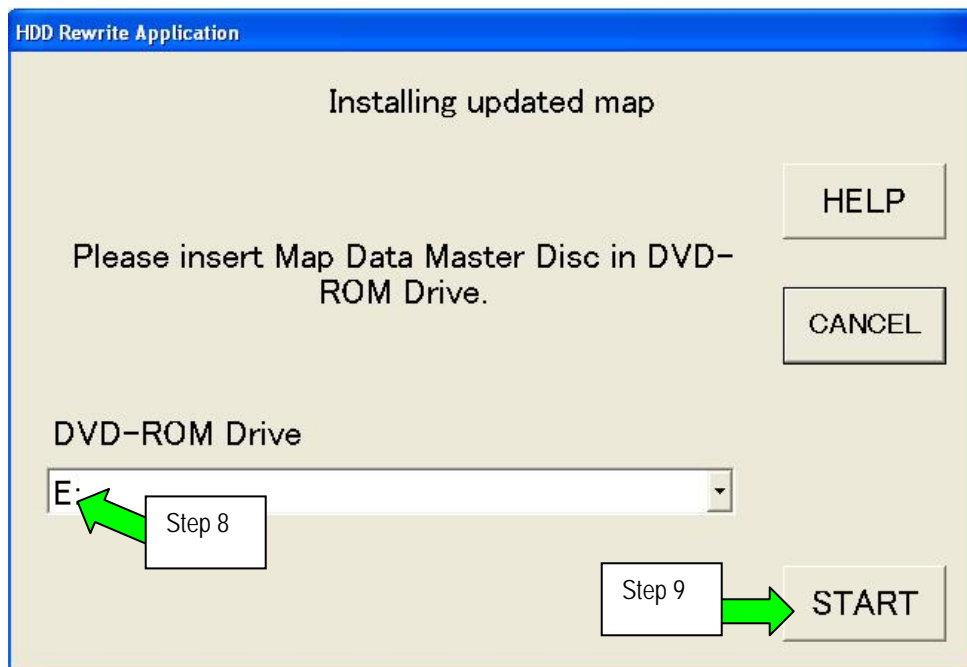

Figure 1-5

- Installation of the update map will start and a progress screen will display.
- Installation will take several minutes.

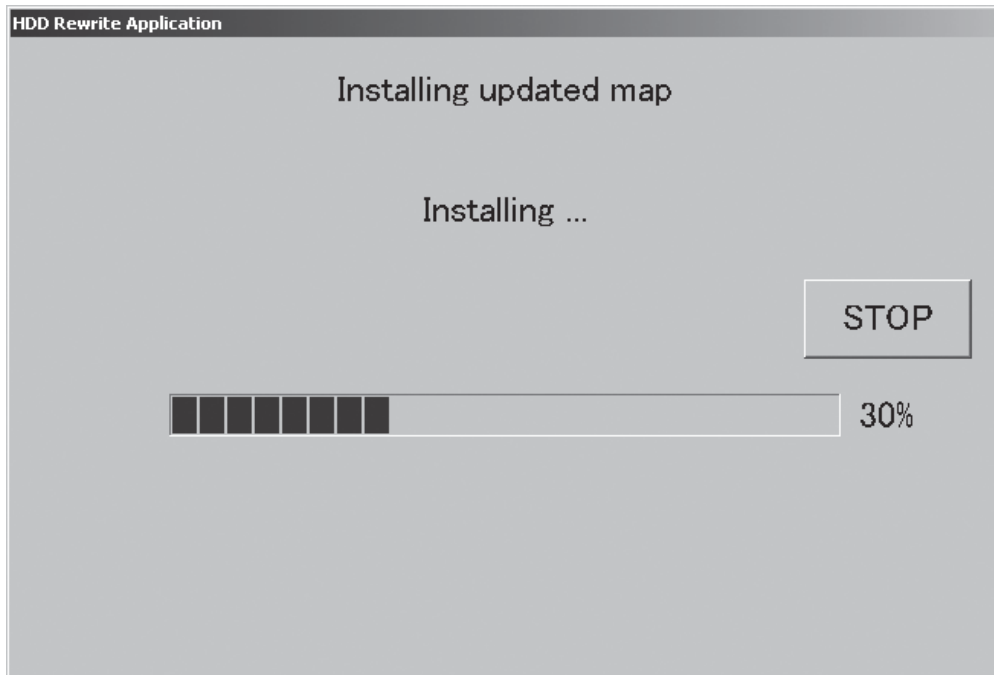

Figure 1-6

- At about 35% this message will display:

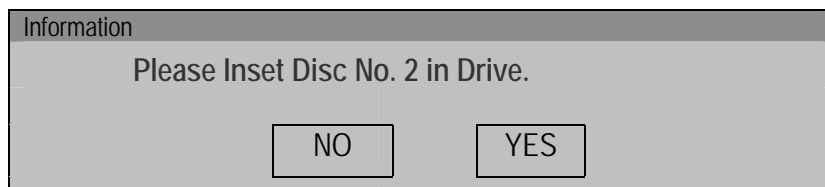

Figure 1-7

- When you get the above message, remove Disc 1; install Disc 2; then select YES.

- When installation is complete the screen shown in Figure 1-8 will display.

10. Select **OK**.

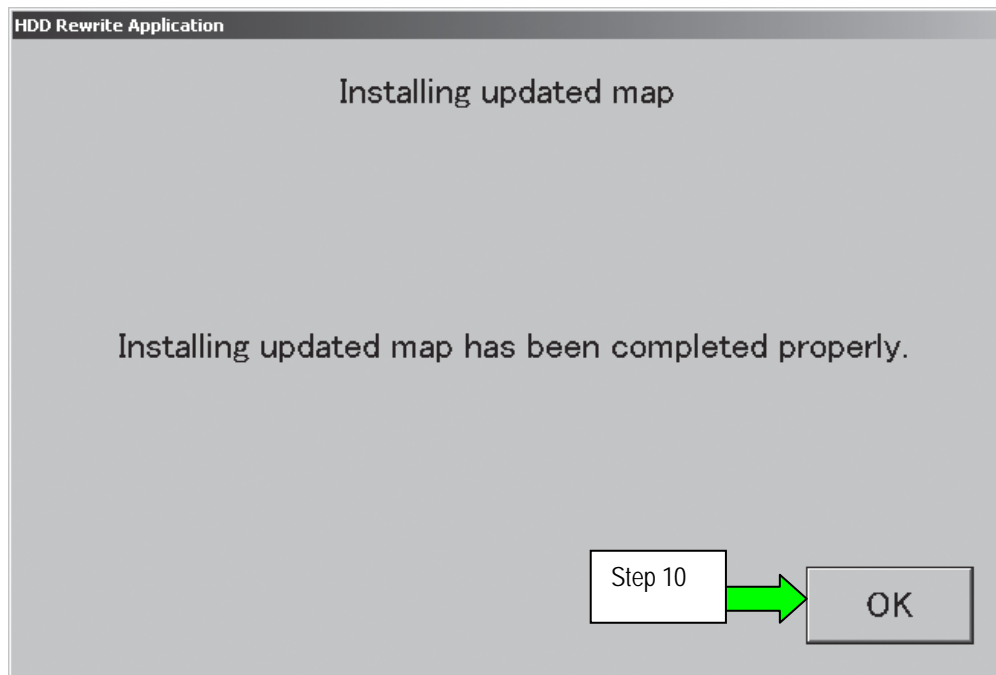

Figure 1-8

11. Select **EXIT**

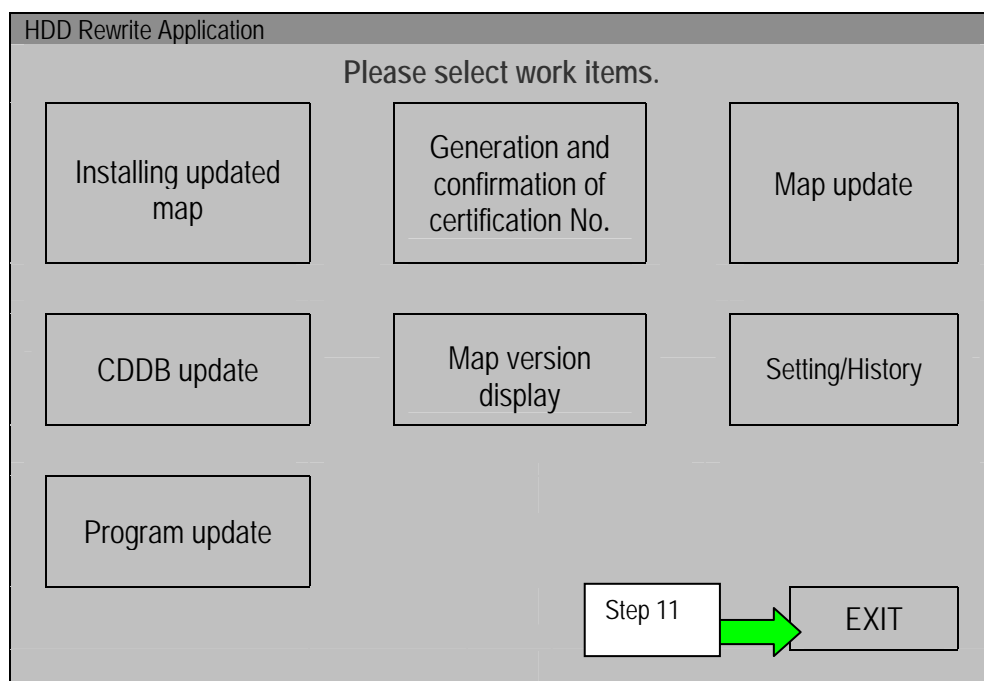

Figure 1-9

12. Remove Disc 2 from the DVD drive.

13. Select the **Safely Remove Hardware** icon on the “system tray” which is displayed in the bottom right of the C-III computer screen.

- You may need to click on the “expand arrow” to expand the icon selections.

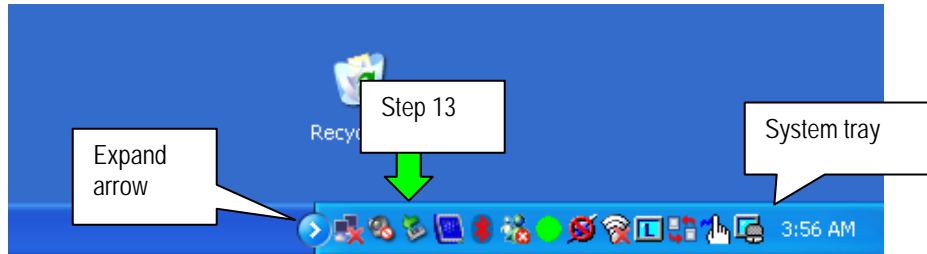

Figure 1-10

14. Select **Safely remove USB Mass Storage Device - Drive (E:)**

- The drive name will likely be E, but may be different depending on the drive configuration of your C-III computer.

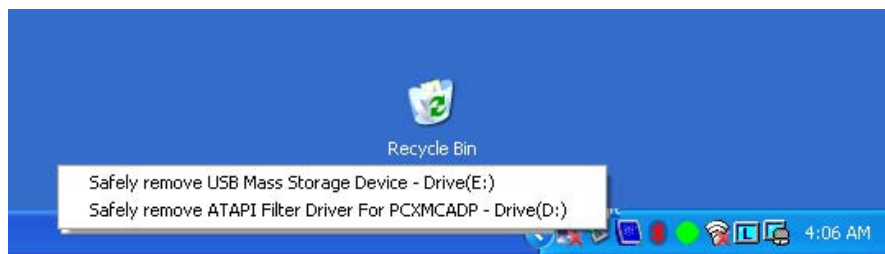

Figure 1-11

15. Disconnect the C-III DVD drive from the C-III computer.



Figure 1-12



## SECTION 2: CONNECTING C-III TO THE AUDIO SYSTEM

- Make sure the vehicle battery is charged and connected.
- Do not touch the CF (Compact Flash) adapter with wet hands.

### CAUTION:

- **Do not turn the ignition ON** when the C-III computer is connected to the audio system with the CF (Compact Flash) adapter.
- **Obey the following instruction**; otherwise the CF Adapter, CF card slot, or navigation system may be damaged.

1. Make sure the ignition is OFF.
2. Close any applications that are running on the C-III computer.
  - If the C-III computer is OFF, leave it OFF for now.
3. Connect USB cable to the C-III computer.
  - Make sure connector is fully inserted.



Figure 2-1

4. Connect the other end of the USB cable to the CF (Compact Flash) adapter.
  - Make sure connector is fully inserted.

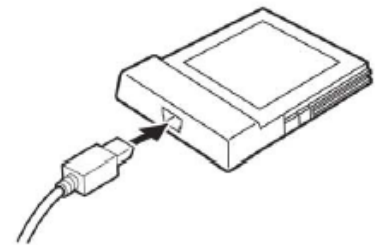

Figure 2-2

5. Carefully insert the CF adapter into the CF card slot of the vehicle audio/navigation system.
  - Label side UP.
  - Insert it all the way (firmly), to its stop.

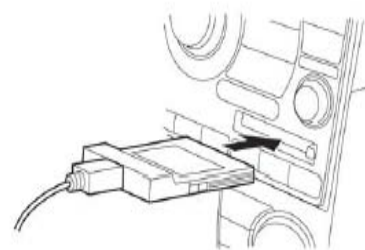

Figure 2-3

### SECTION 3: UPDATING THE AUDIO SYSTEM SOFTWARE

1. Connect the C-III computer power cord (A.C. adapter or vehicle D.C. adapter).
  - Updating the audio system may take a few minutes. Connecting the power cord will ensure the C-III computer maintains power during the update.
  - Vehicle ignition **must remain OFF**.

2. In ASIST, select Information Tool Box and **HD Navi. Tools**.



Figure 3-1

3. Select Install Map Update



Figure 3-2

4. Select Program update

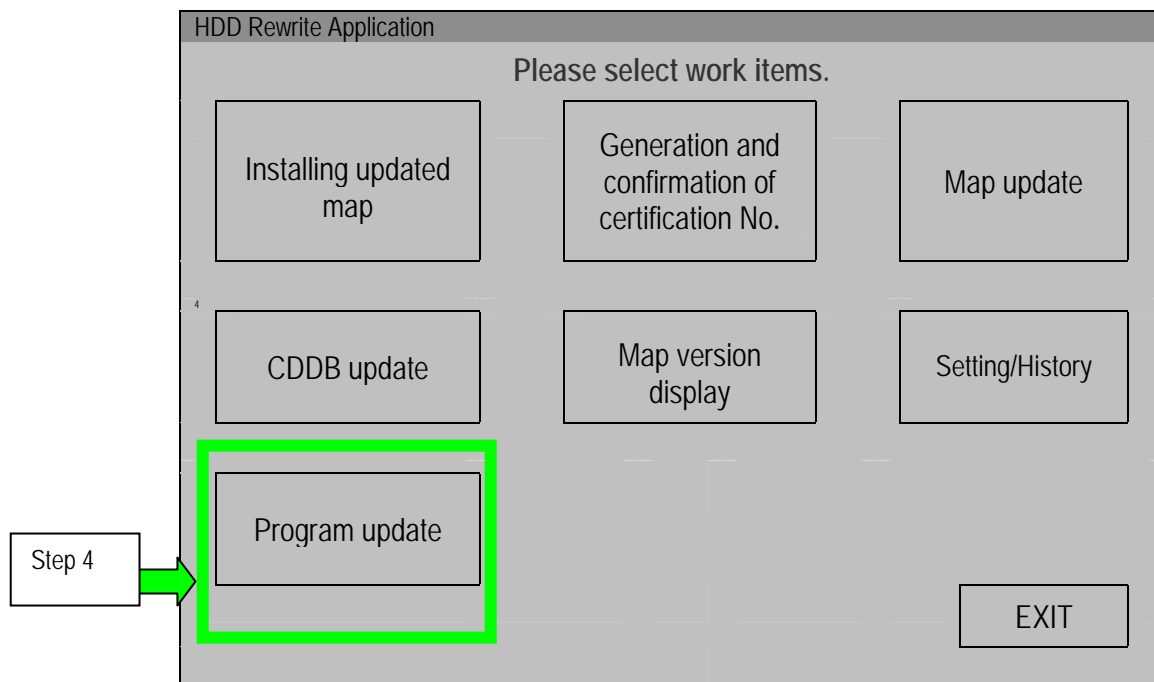

Figure 3-3

5. Select **NEXT**

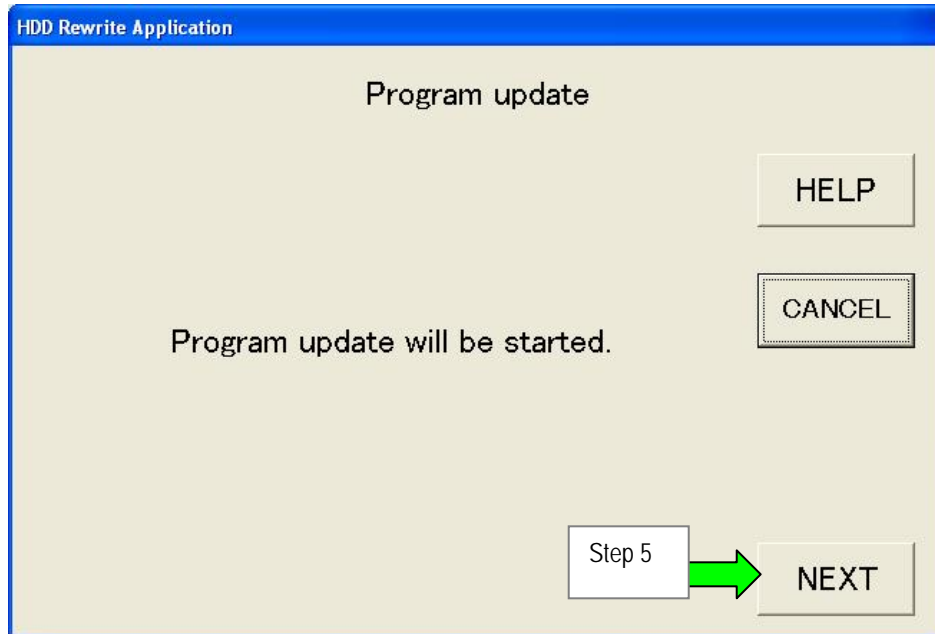

Figure 3-4

6. Confirm the version number of "New version of program data" is higher than "Current version of program data".

7. Select **START**

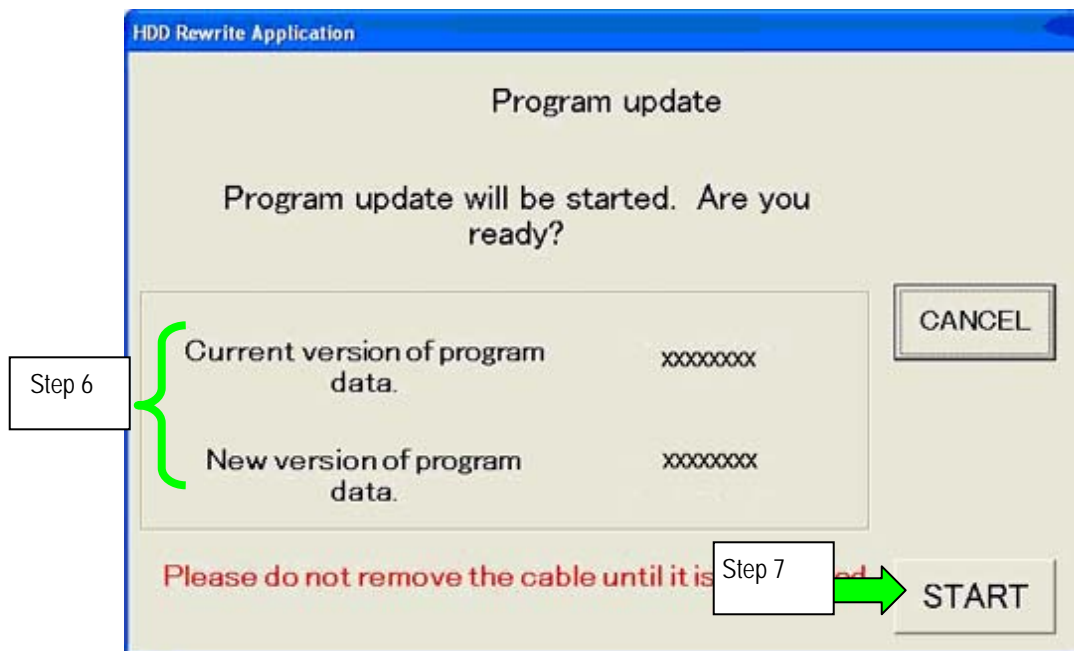

Figure 3-5

- Audio system update will begin and a progress bar will be displayed as shown in Figure 3-6.

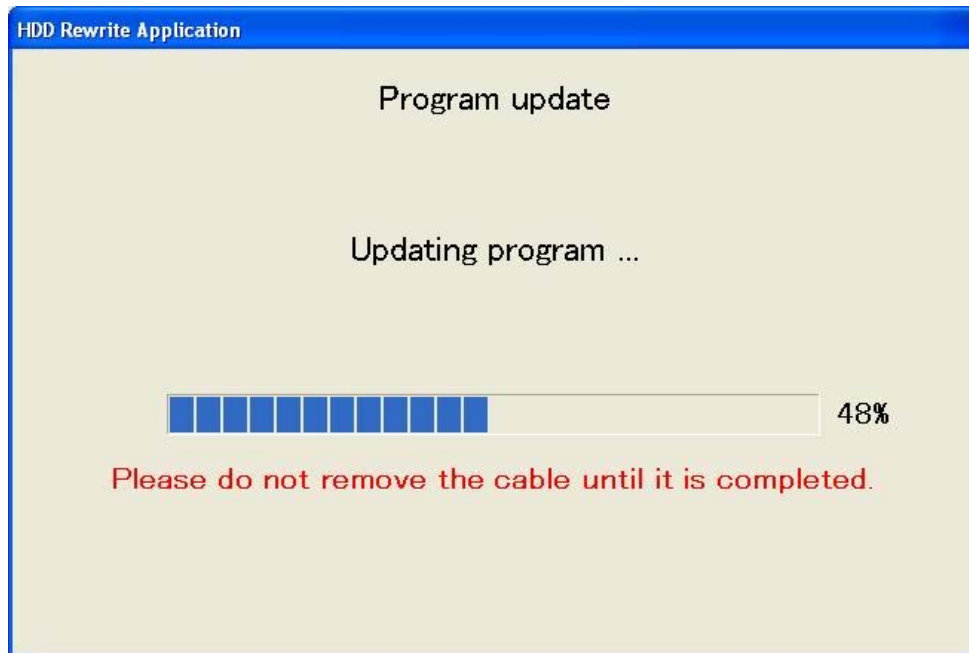

Figure 3-6

- When update is complete the screen in Figure 3-7 will display.

8. Select OK

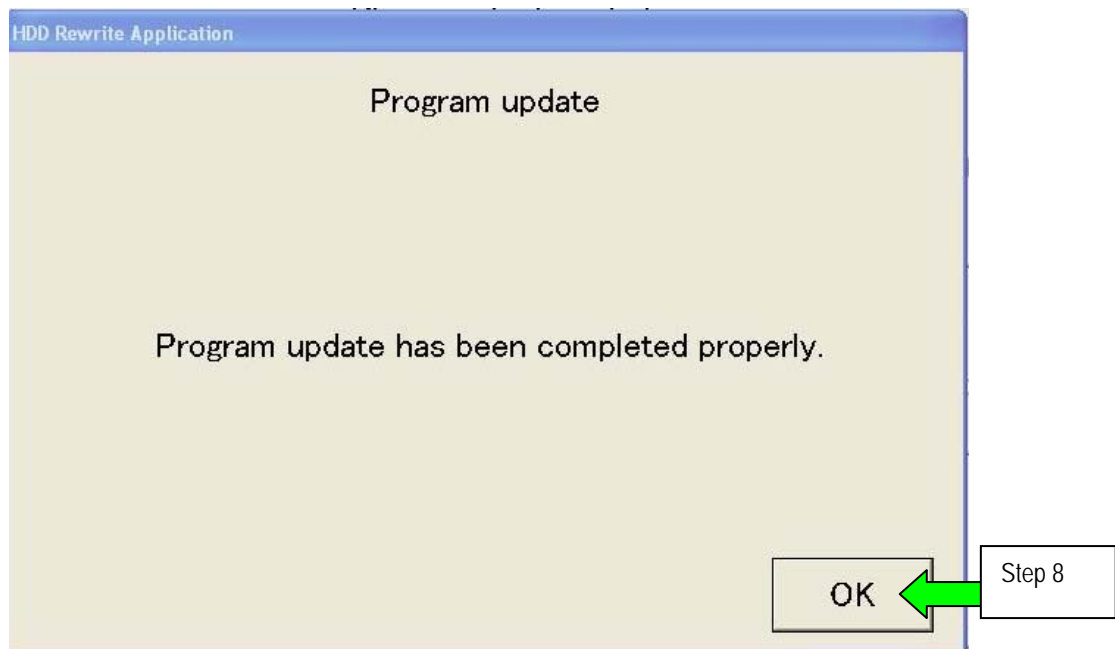

Figure 3-7

## SECTION 4: DISCONNECTING C-III and CF (Compact Flash) ADAPTER.

**NOTE:** Do not touch the CF (Compact Flash) adapter with wet hands.

1. Select **EXIT**

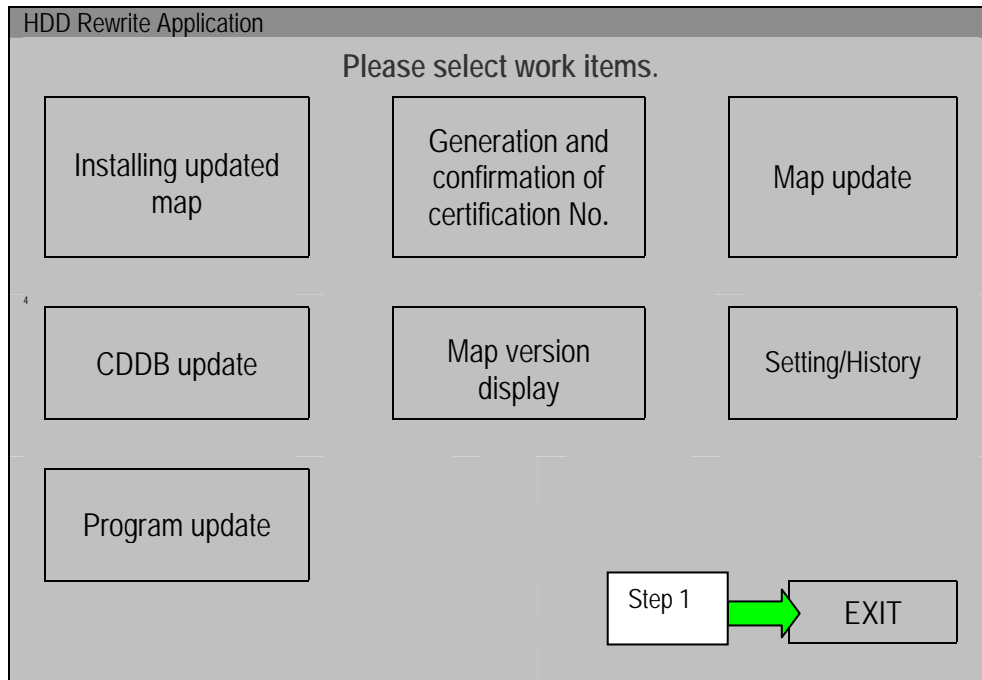

Figure 4-1

2. Select the **Safely Remove Hardware** icon on the "system tray" which is displayed in the bottom right of the C-III computer screen.
  - You may need to click on the "expand arrow" to expand the icon selections.

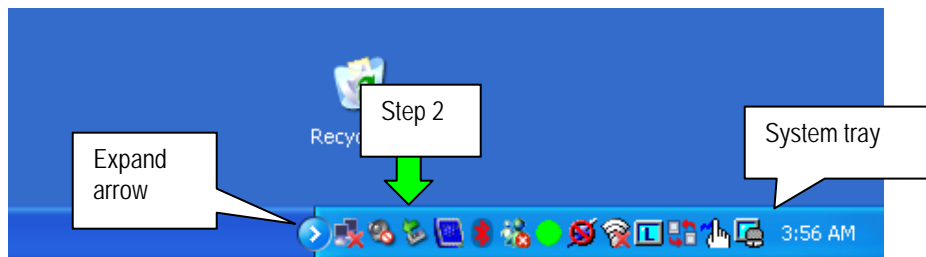

Figure 4-2

3. Select **Safely remove USB Mass Storage Device**



Figure 4-3

4. After the message "Safe to Remove Hardware" is displayed, disconnect the USB cable from the C-III computer.

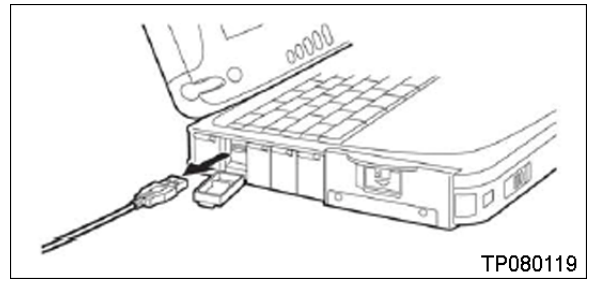

Figure 4-4

5. Push the Eject button at the right of the CF card slot and carefully remove the CF adapter.

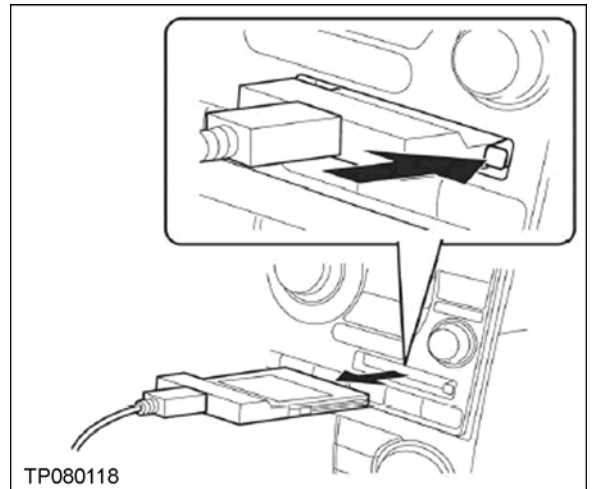

Figure 4-5

**NOTE:** When not in use, store the CF adapter in its original plastic bag.

## SECTION 5: VERIFYING THE UPDATE RESULT

- Make sure the CF adapter is disconnected from the navigation system before performing the following steps.

1. Turn the ignition ON.

- If the ignition is already ON, turn it OFF and then back ON.

2. The Program Loading screen as shown in Figure 5-1 will display.

- This process may take only a few seconds to complete or it may take a few minutes.

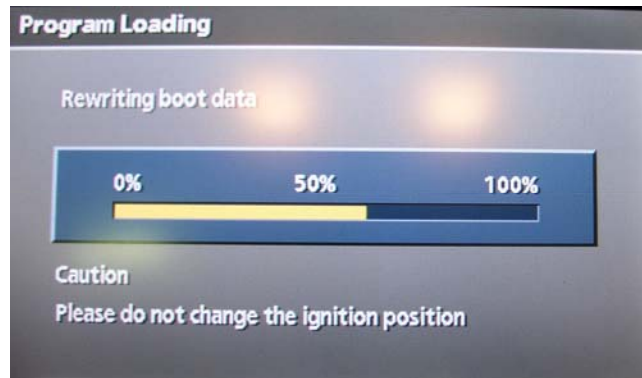

Figure 5-1

3. Operate the audio system and confirm it is operating correctly.

