

Classification:
EL08-025a

Reference:
ITB09-004a

Date:
February 9, 2009

EX35, G35, G37, M, QX56; NAVIGATION SYSTEM LOCKS UP / SCREEN FREEZES

The Action section of this bulletin has been amended. No other content has changed.
Discard all earlier versions of this bulletin.

APPLIED VEHICLES: 2008 EX35 (J50)
2007-2008 G35 (V36)
2008 G37 (CV36)
2008 M (Y50)
2008-2009 QX56 (JA60)

APPLIED VIN / DATE: EX35 2WD vehicles built before: JNKAJ09E(*)8M303263 / 1-18-08
EX35 AWD vehicles built before: JNKAJ09F(*)8M356216 / 1-19-08
G35 2WD vehicles built before: JNKBV61E(*)8M215553 / 1-14-08
G35 AWD vehicles built before: JNKBV61F(*)8M264054 / 1-14-08
G37 vehicles built before: JNKCV64E(*)8M118152 / 1-14-08
M35 2WD vehicles built before: JNKBY01E(*)8M500674 / 1-16-08
M35 AWD vehicles built before: JNKBY01F(*)8M550953 / 1-17-08
M45 2WD vehicles built before: JNKAY01E(*)8M604816 / 1-17-08
M45 AWD vehicles built before: JNKAY01F(*)8M653465 / 1-17-08
QX56 vehicles built before: 5N3AA08(**)9N900007 / 4-9-08

IF YOU CONFIRM:

The Navigation system locks up or the screen freezes and the Applied Vehicle was built before the Applied Date / VIN range.

NOTE: This condition, if it should occur, is intermittent and can be reset to normal condition by cycling the ignition switch off and on or waiting approximately five (5) minutes.

ACTION:

Update the audio system software using the procedure in this bulletin.

IMPORTANT:

- If the system is otherwise operating normally this bulletin applies.
- If the system has DIFFERENT symptoms than what is described above this bulletin DOES NOT APPLY. Refer to ASIST for further diagnostic assistance.

NOTE: Make sure to use 08-09 or later Map Data Master Discs.

IMPORTANT: The purpose of "ACTIONS" (above) is to give you a quick idea of the work you will be performing. You MUST closely follow the entire Service Procedure as it contains information that is essential to successfully completing this repair.

Infiniti Bulletins are intended for use by qualified technicians, not 'do-it-yourselfers'. Qualified technicians are properly trained individuals who have the equipment, tools, safety instruction, and know-how to do a job properly and safely. NOTE: If you believe that a described condition may apply to a particular vehicle, DO NOT assume that it does. See your Infiniti dealer to determine if this applies to your vehicle.

CLAIMS INFORMATION

Submit a Primary Operation (PO) line claim using the following claims coding:

DESCRIPTION	OP CODE	SYM	DIA	FRT
Audio System Software Update	RX84AA	HB	32	0.6

SERVICE PROCEDURE

The HDD update kit (P/N: J-48850) and the 08–09 Map Data Master Discs (2 disc set – J-48850-MY09) are required to update the audio system software. These items were previously shipped to each dealer as part of the essential tool program.

- 08–09 Map Data Master Discs (2 disc set).



Figure A

HDD update kit contents

- HDD Rewrite software (obsolete; now available via ASIST synchronization)
- 07-08 HDD Data Upgrade Master Disc 1 & 2 (superseded by 08-09 discs)
- CF (Compact Flash) Adapter
- USB cable
 - These items can be purchased from TECH-MATE at 1-800-662-2001

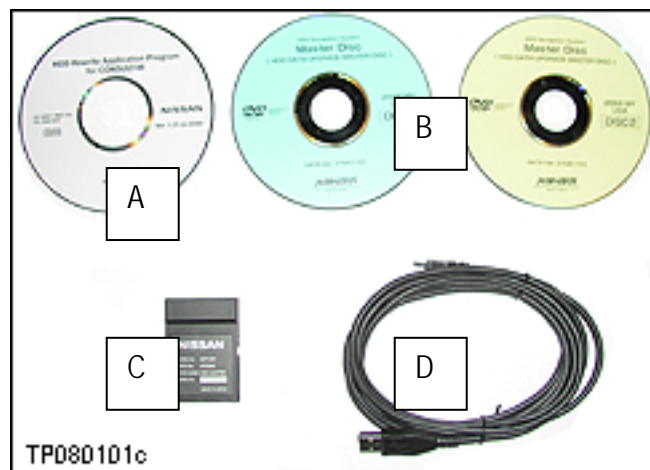

Figure B

NOTE: The HDD update kit was assembled prior to the availability of ASIST download for the HDD rewrite software. The kit also includes the 07-08 Upgrade Master Discs which have been superseded by the 08-09 Map Data Master Discs. Discs "A" and "B" above are no longer needed.

IMPORTANT:

- Make sure your ASIST has been freshly synchronized and all C-III upgrades have been installed. The HDD (Hard Disc Drive) rewrite software is delivered to your C-III via ASIST synchronization.
- If the ASIST has been freshly synchronized then HDD rewrite software is on your C-III.

Overview of the Audio System Software Update

This procedure is divided into 5 sections. Complete each section in the following order:

SECTION 1: Installing the Map Data Master Discs into the CONSULT-III (C-III).....	Page 3
(This is required only once)	
SECTION 2: Connecting C-III to the Audio System.....	Page 9
SECTION 3: Updating the Audio System.....	Page 10
SECTION 4: Disconnecting the C-III and CF (Compact Flash) Adapter.....	Page 14
SECTION 5: Verifying the Update Result.....	Page 16

SECTION 1: INSTALLING THE MAP DATA MASTER DISCS INTO THE C-III

- The audio system update software is contained on the 08–09 Map Data Master Discs (2 disc set – J-48850-MY09). See page 2.
- The 08–09 Map Data Master Discs need to be installed on your C-III only once. It is not necessary to install the Data Master Discs each time you perform an audio system update.
- If 08–09 Map Data Master Discs are already installed in your C-III computer, you can skip to Section 2 on page 9.

1. Connect the C-III DVD drive to the C-III computer with the USB cable.
2. Turn ON the C-III computer.
3. Open / start ASIST.



Figure 1-1

4. Select Information Tool Box and HD Navi. Tools.



Figure 1-2

5. Select Install Map Update

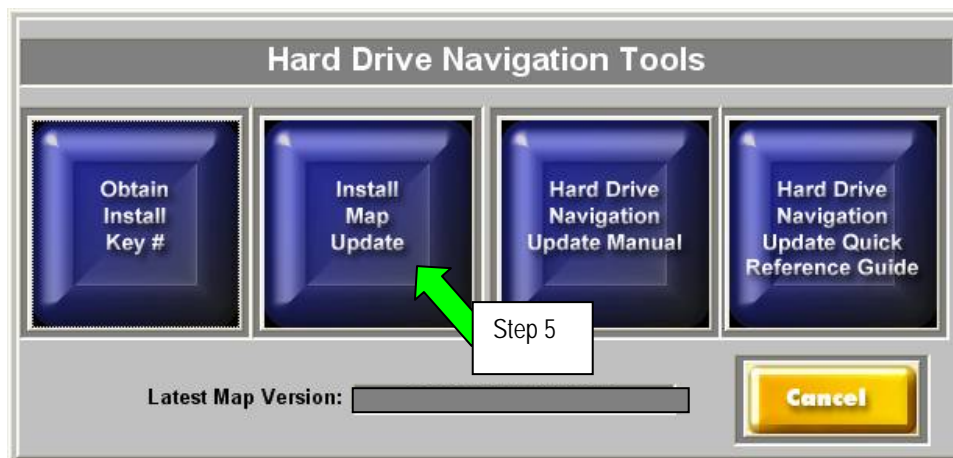

Figure 1-3

6. Select **Installing updated map**

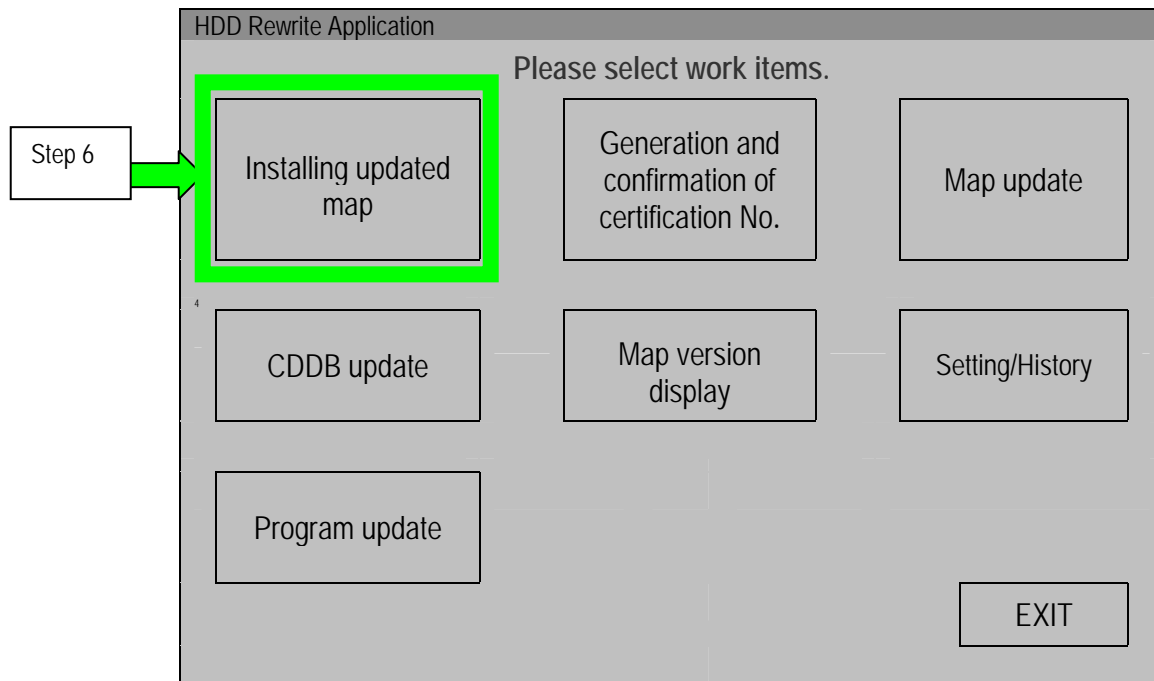

Figure 1-4

7. Insert the Map Data Master Disc 1 into the C-III DVD drive.

8. Confirm the correct name of the DVD drive is displayed (see Figure 1-5).

- "E" is likely the correct name for the DVD drive.
- The DVD drive name may be different depending on the drive configuration of your C-III computer.

9. Select **START**

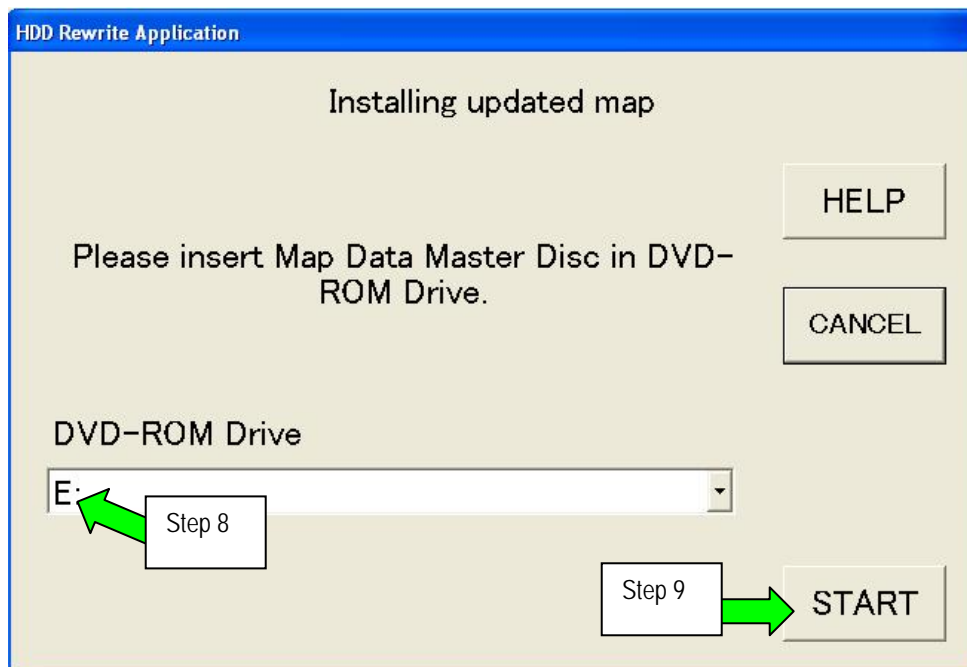

Figure 1-5

- Installation of the update map will start and a progress screen will display.
- Installation will take several minutes.

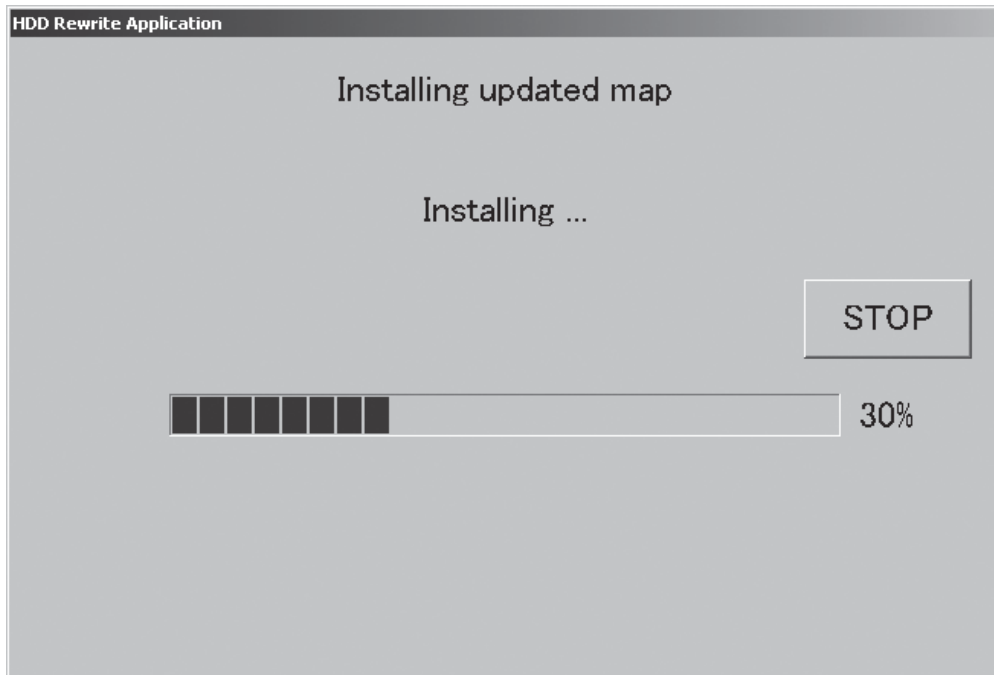

Figure 1-6

- At about 35% this message will display:

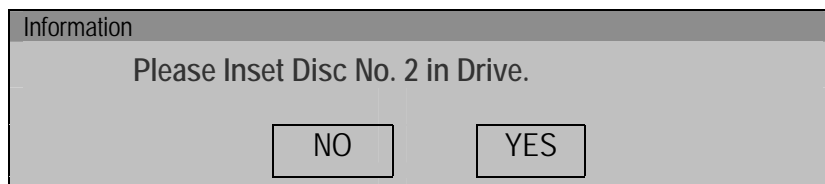

Figure 1-7

- When you get the above message, remove Disc 1; install Disc 2; then select YES.

- When installation is complete the screen shown in Figure 1-8 will display.

10. Select **OK**.

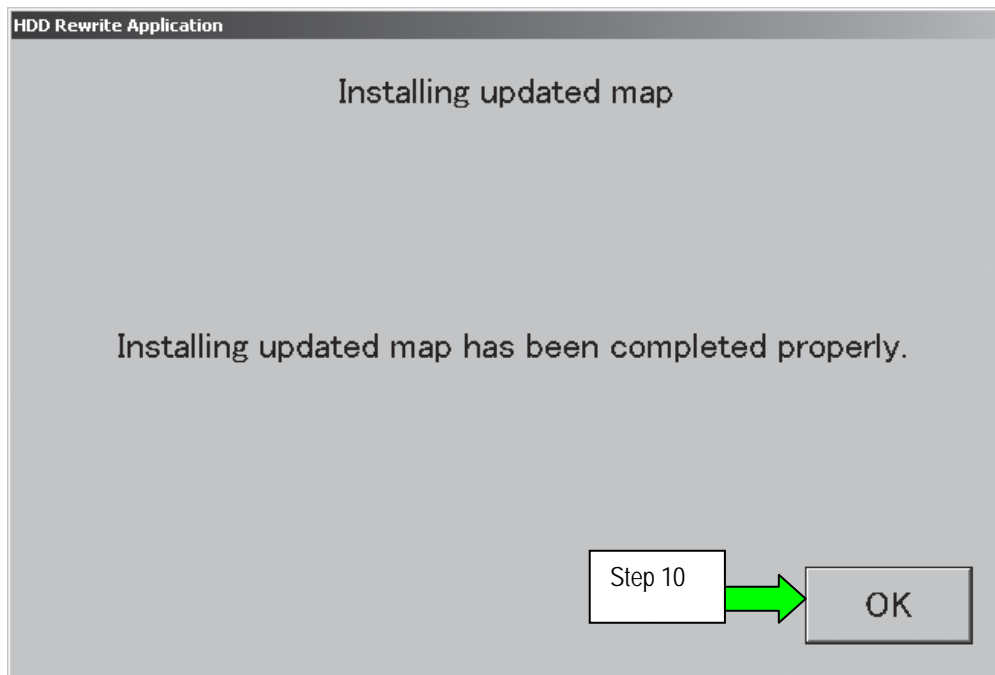

Figure 1-8

11. Select **EXIT**

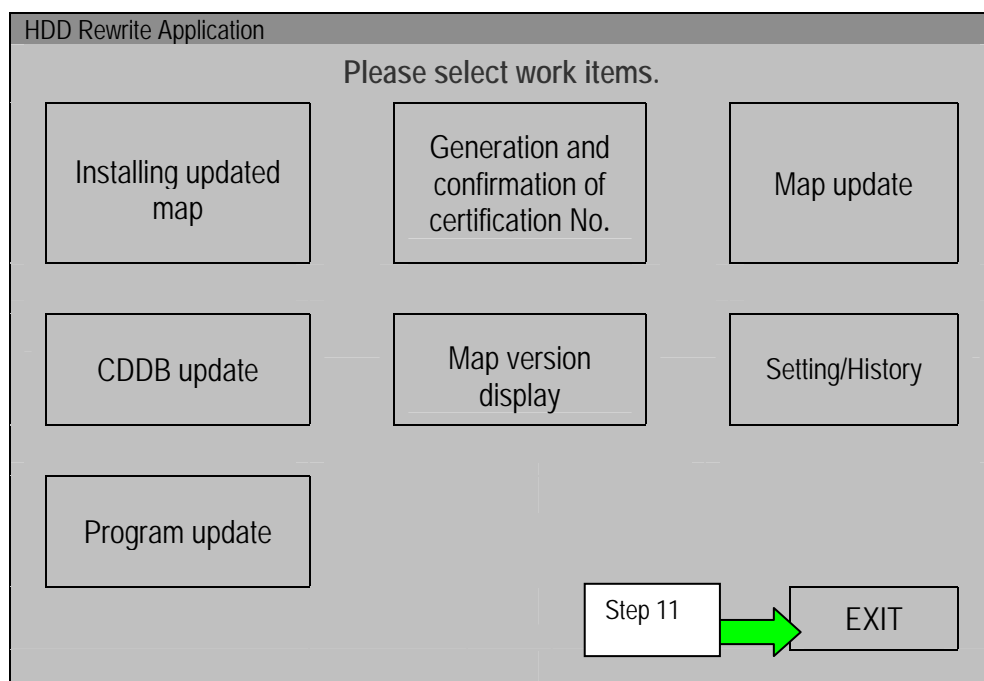

Figure 1-9

12. Remove Disc 2 from the DVD drive.

13. Select the **Safely Remove Hardware** icon on the “system tray” which is displayed in the bottom right of the C-III computer screen.

- You may need to click on the “expand arrow” to expand the icon selections.



Figure 1-10

14. Select **Safely remove USB Mass Storage Device - Drive (E:)**

- The drive name will likely be E, but may be different depending on the drive configuration of your C-III computer.

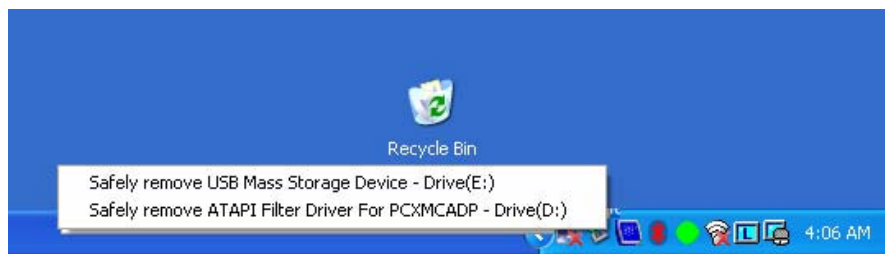

Figure 1-11

15. Disconnect the C-III DVD drive from the C-III computer.



Figure 1-12

SECTION 2: CONNECTING C-III TO THE AUDIO SYSTEM

- Make sure the vehicle battery is charged and connected.
- Do not touch the CF (Compact Flash) adapter with wet hands.

CAUTION:

- **Do not turn the ignition ON** when the C-III computer is connected to the audio system with the CF (Compact Flash) adapter.
- **Obey the following instruction**; otherwise the CF Adapter, CF card slot, or navigation system may be damaged.

1. Make sure the ignition is OFF.
2. Close any applications that are running on the C-III computer.
 - If the C-III computer is OFF, leave it OFF for now.
3. Connect USB cable to the C-III computer.
 - Make sure connector is fully inserted.



Figure 2-1

4. Connect the other end of the USB cable to the CF (Compact Flash) adapter.
 - Make sure connector is fully inserted.

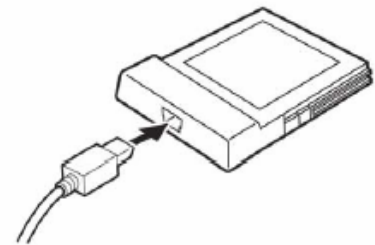

Figure 2-2

5. Carefully insert the CF adapter into the CF card slot of the vehicle audio/navigation system.
 - Label side UP.
 - Insert it all the way (firmly), to its stop.

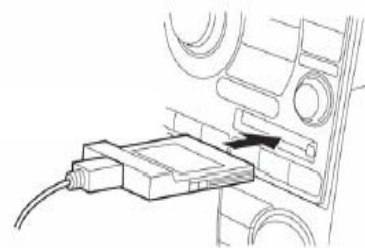

Figure 2-3

SECTION 3: UPDATING THE AUDIO SYSTEM SOFTWARE

1. Connect the C-III computer power cord (A.C. adapter or vehicle D.C. adapter).
 - Updating the audio system may take a few minutes. Connecting the power cord will ensure the C-III computer maintains power during the update.
 - Vehicle ignition **must remain OFF**.

2. In ASIST, select Information Tool Box and HD Navi. Tools.



Figure 3-1

3. Select Install Map Update



Figure 3-2

4. Select Program update

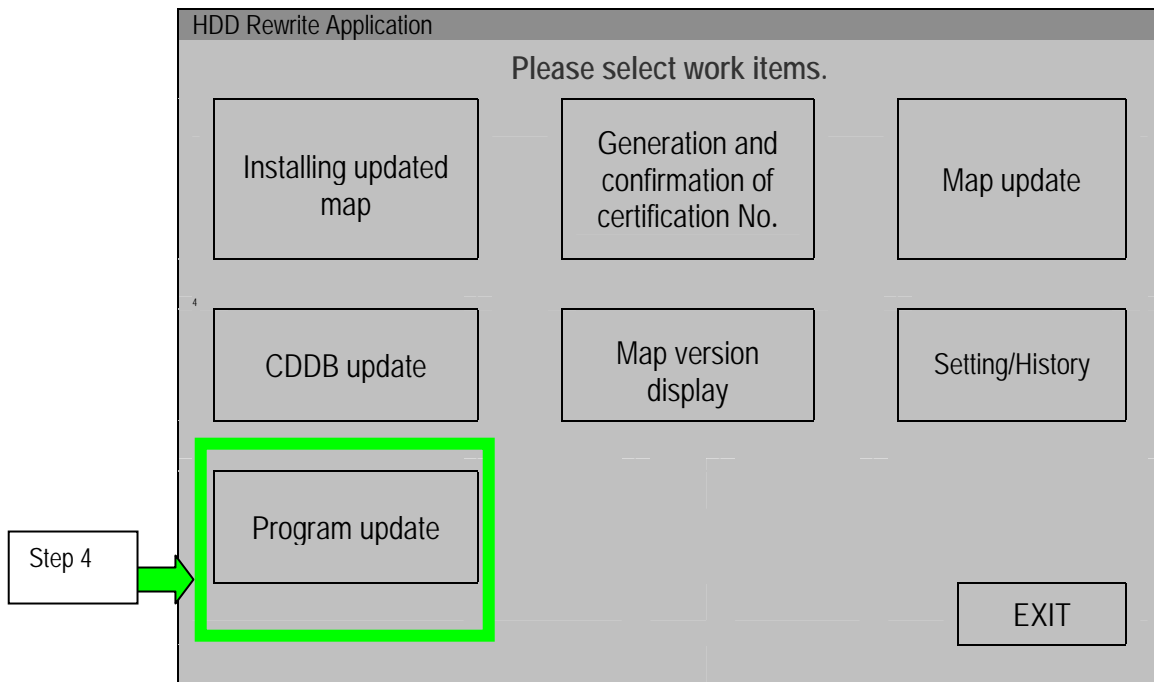

Figure 3-3

5. Select **NEXT**

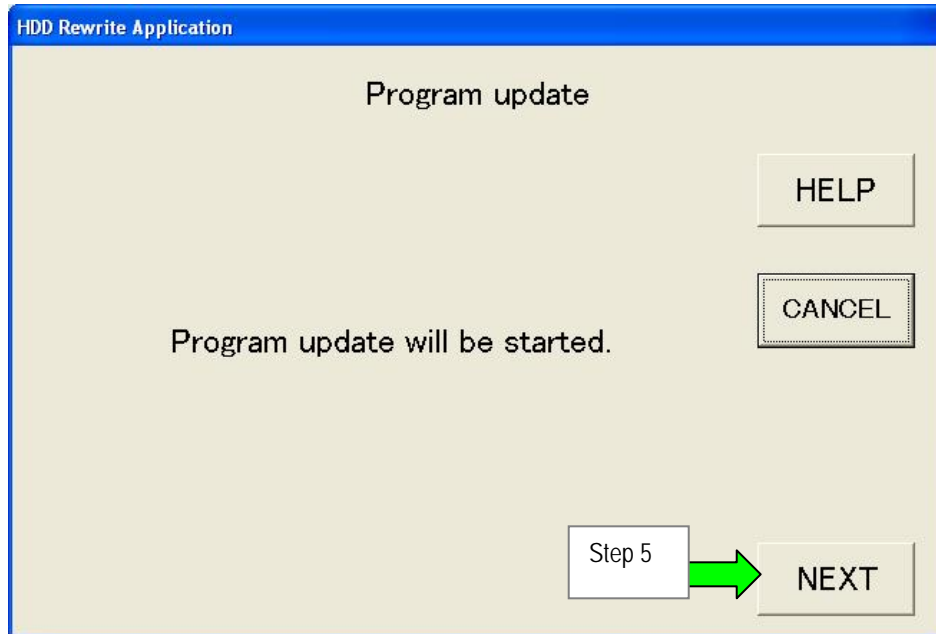

Figure 3-4

6. Confirm the version number of "New version of program data" is higher than "Current version of program data".

7. Select **START**

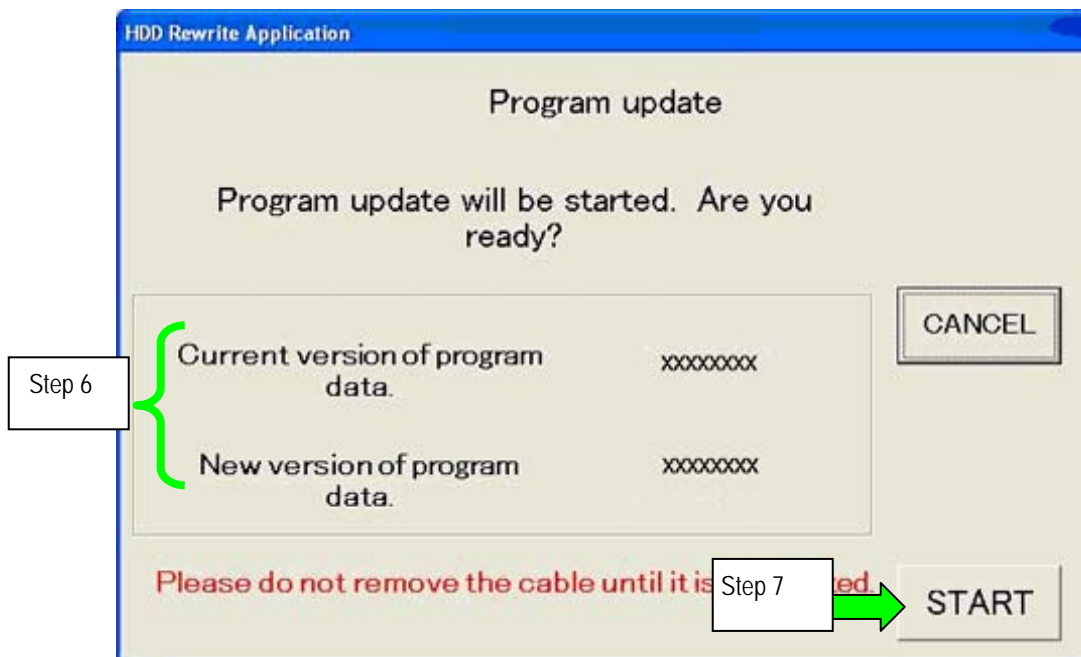

Figure 3-5

- Audio system update will begin and a progress bar will be displayed as shown in Figure 3-6.

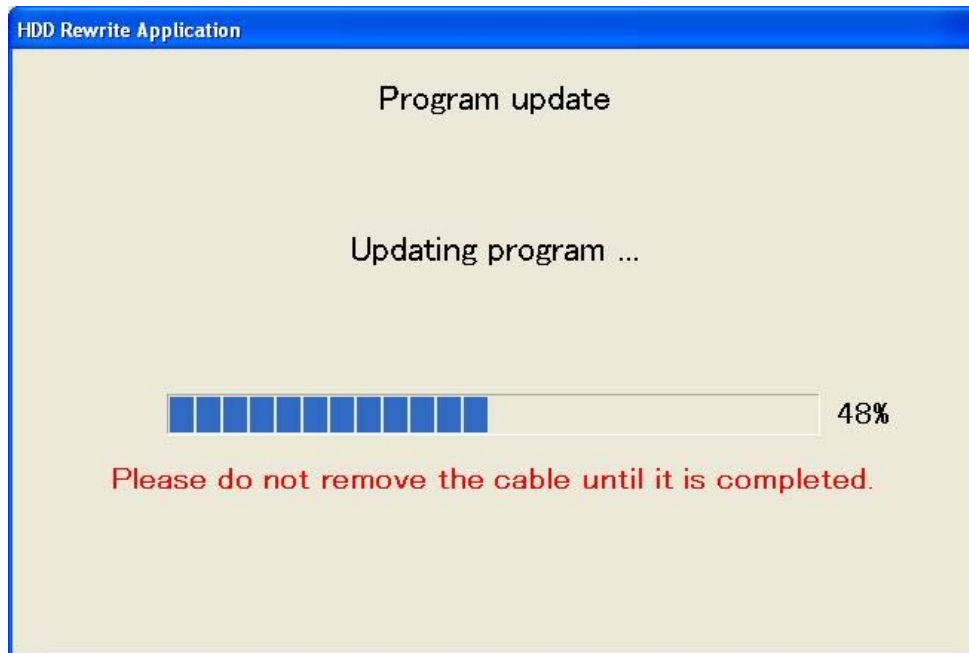

Figure 3-6

- When update is complete the screen in Figure 3-7 will display.

8. Select OK

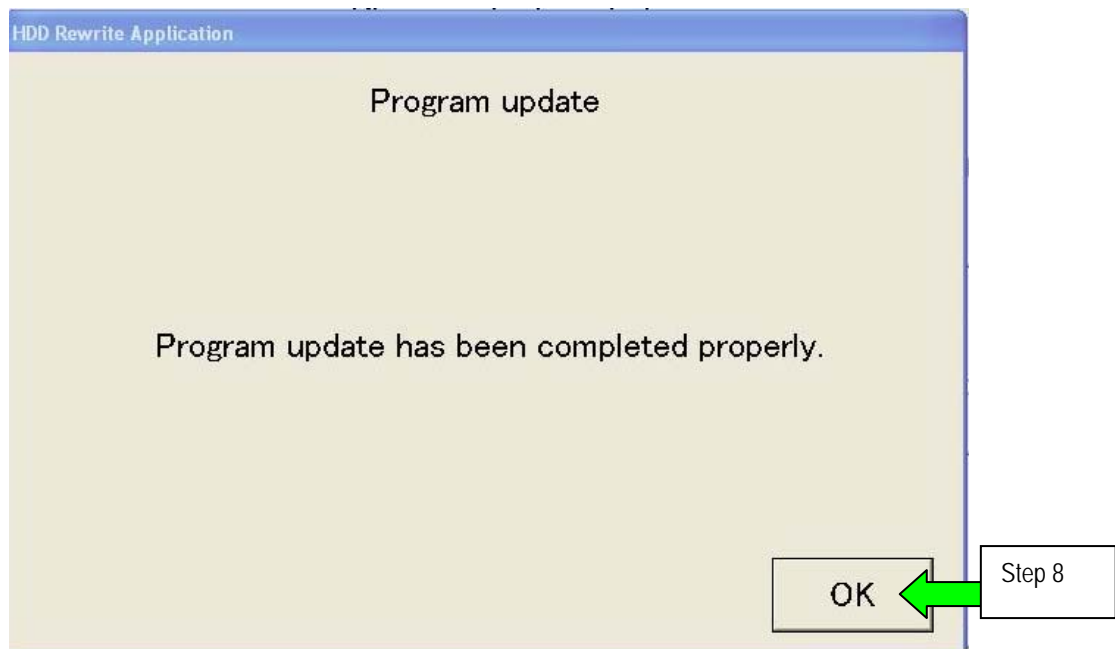

Figure 3-7

SECTION 4: DISCONNECTING C-III and CF (Compact Flash) ADAPTER.

NOTE: Do not touch the CF (Compact Flash) adapter with wet hands.

1. Select **EXIT**

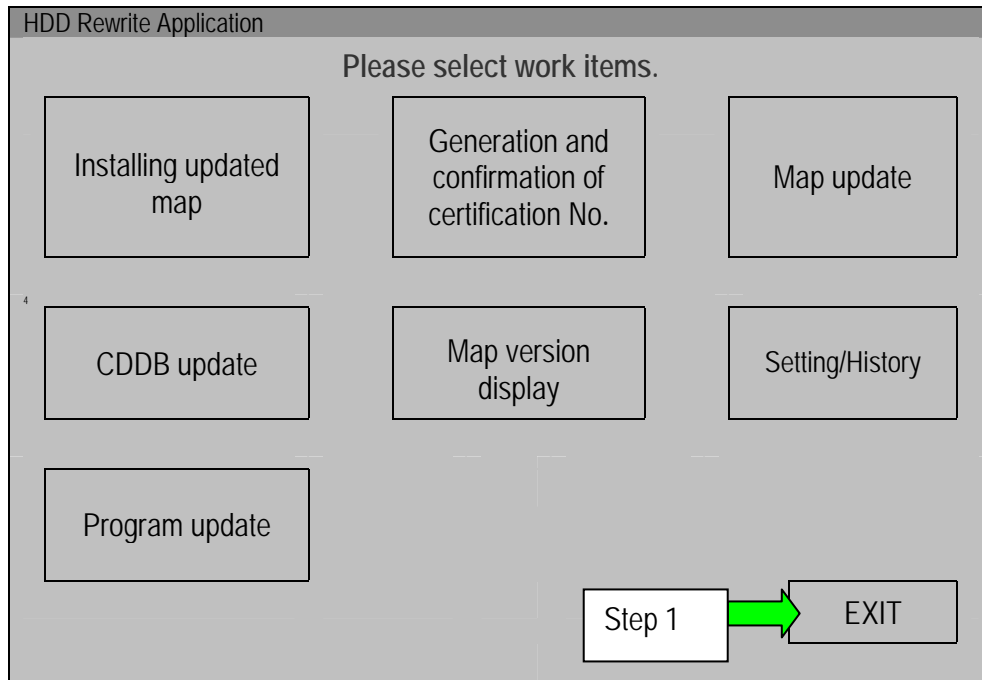

Figure 4-1

2. Select the **Safely Remove Hardware** icon on the "system tray" which is displayed in the bottom right of the C-III computer screen.
 - You may need to click on the "expand arrow" to expand the icon selections.

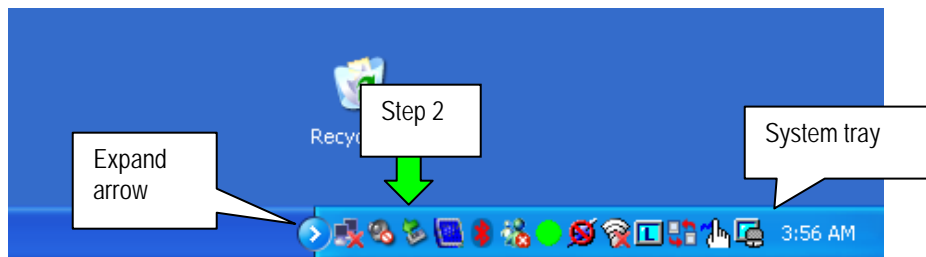

Figure 4-2

3. Select **Safely remove USB Mass Storage Device**



Figure 4-3

4. After the message "Safe to Remove Hardware" is displayed, disconnect the USB cable from the C-III computer.

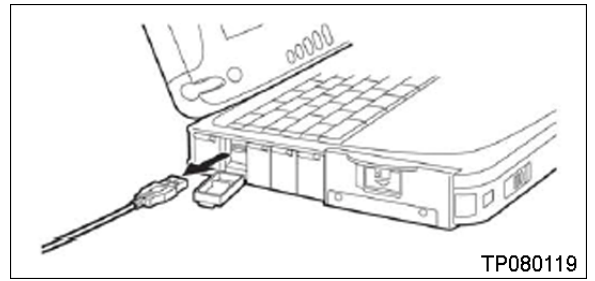

Figure 4-4

5. Push the Eject button at the right of the CF card slot and carefully remove the CF adapter.

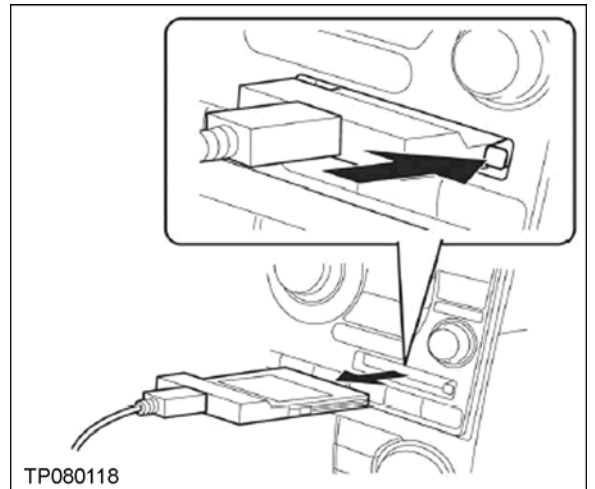

Figure 4-5

NOTE: When not in use, store the CF adapter in its original plastic bag.

SECTION 5: VERIFYING THE UPDATE RESULT

- Make sure the CF adapter is disconnected from the navigation system before performing the following steps.
1. Turn the ignition ON.
 - If the ignition is already ON, turn it OFF and then back ON.
 2. The Program Loading screen as shown in Figure 5-1 will display.
 - This process may take only a few seconds to complete or it may take a few minutes.

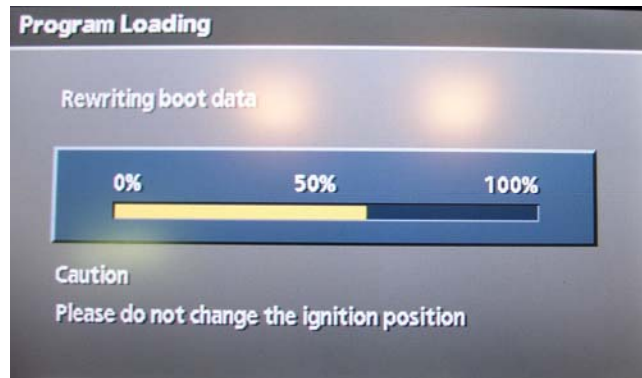

Figure 5-1

