

Classification:

EL03-044e

Reference:

ITB04-020e

COPYRIGHT© NISSAN NORTH AMERICA, INC.

Date:

March 12, 2008

TRAILER LIGHT WIRING

This bulletin has been amended to remove 2008 MY vehicles. See the 2008 Infiniti Towing Guide for details. Please discard all previous copies of ITB04-020.

APPLIED VEHICLES:

- 2003 – 2004 I35 (CA33)
- 2003 – 2006 Q45 (F50)
- 2003 – 2006 G35 Sedan (V35)
- 2007 G35 Sedan (V36)
- 2003 – 2007 G35 Coupe (CV35)
- 2003 – 2004 M45 (Y34)
- 2006 – 2007 M35/M45 (Y50)

SERVICE INFORMATION

NOTE: This bulletin provides information to be shared with all affected customers.

- This TSB contains the appropriate hookup points for connecting a trailer light wiring harness to the towing vehicle's electrical system.
- The wiring diagrams contained in this bulletin are for Infiniti vehicles that have trailer towing capability (see the owners manual) but do not have a Genuine Infiniti accessory towing kit (with wiring) available.
- When splicing into the vehicle electrical system, a power-type module/converter must be used to provide power for all trailer lighting. A power-type module/converter uses the vehicle battery as a direct power source for all trailer lights while using the vehicle tail lamp, stoplight, and turn signal circuits only as a signal source. (See the illustration on the next page.) **The module/converter must draw no more than 5 milliamps from the vehicle turn signal circuits and no more than 15 milliamps from the stop and tail lamp circuits.**

CAUTION: Using a module/converter that exceeds these power requirements listed above may negatively affect the performance and function of the vehicle's electrical system.

See a professional trailer dealer or trailer rental agency for installation of the proper equipment.

Customers who inquire about towing should be reminded of the following:

- Always check for correct operation of the turn signals, stoplights, and taillights every time a trailer is hitched up for towing.
- The towing capacity for I35, G35 Sedan and Coupe, M35/M45, and Q45 is 1,000 lbs.

For more information, customers should be referred to the Owner's Manual as well as the Infiniti Towing Guide, available online at www.Infiniti.com.

POWER MODULE / CONVERTER

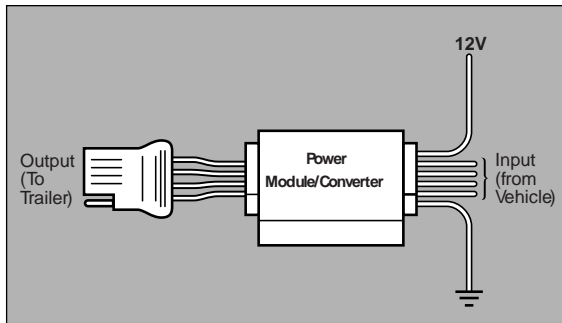

CAUTION: Do NOT connect the trailer wiring directly to the vehicle wiring. Splice the Input side of the Power Module/Converter into the vehicle wiring ONLY. See the below illustrations for the splicing locations.

KEY TO WIRING

LIGHT CONNECTORS¹

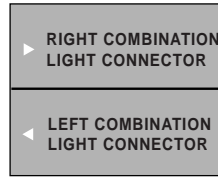

COLOR CODE FOR WIRING²

BLACK	B	YELLOW	Y
WHITE	W	LIGHT GREEN	LG
RED	R	PINK	P
GREEN	G	GREY	GR
BLUE	L	SKY BLUE	SB
PURPLE	PU or V (Violet)		
ORANGE	OR or O		
Base color/stripe color			

¹ For reference, connector numbers correspond to service manual wiring diagrams.

² Wire and sensor colors subject to change.

2003 - 2004 I35

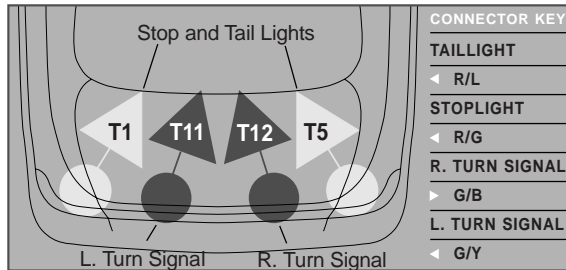

2003 - 2004 M45

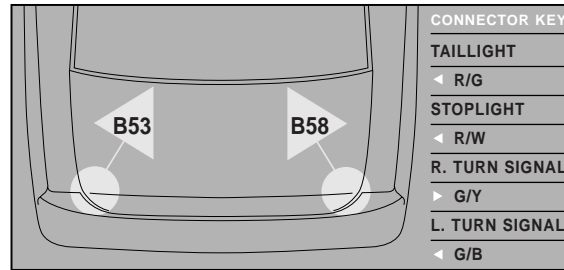

2003 - 2006 G35 Sedan

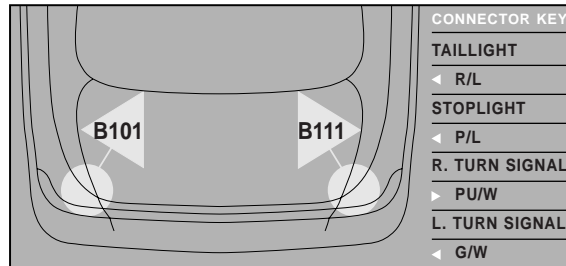

2006 - 2007 M35/M45

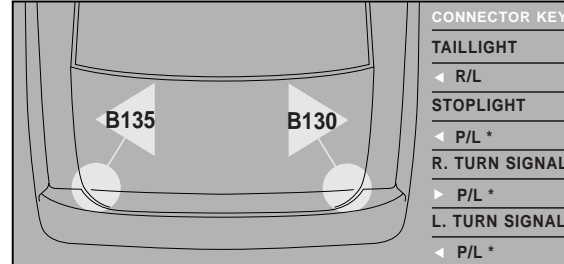

* Use a DVOM to determine the difference.

2003 - 2006 G35 Coupe

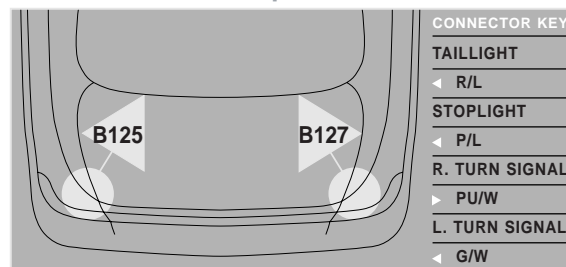

2003 - 2006 Q45

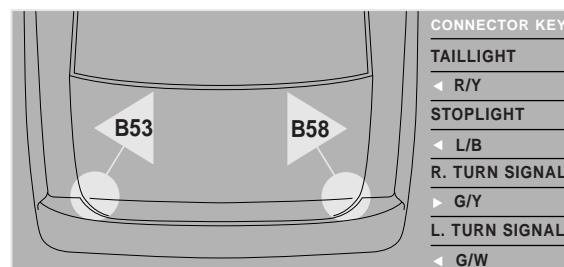

2007 G35 Sedan

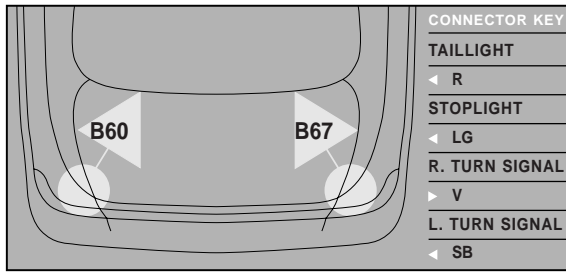

2007 G35 Coupe

